

Timbre scope shots

Fold pot set to zero, input 24Hz sine.

Upper wave is input lower is point on circuit. Note – voltage scale is changed to properly show the waveform, either 1 2 or 5V as indicated

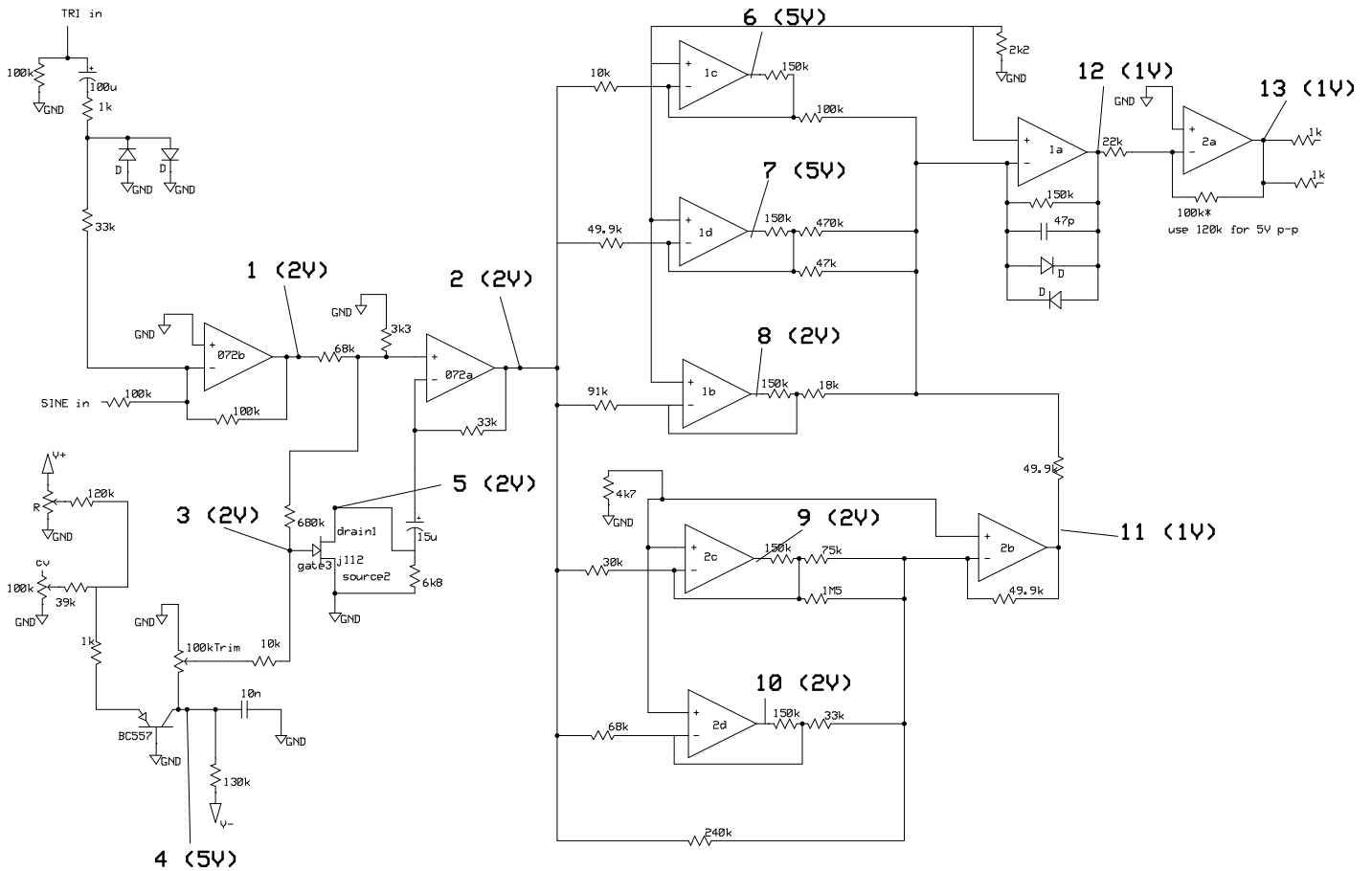

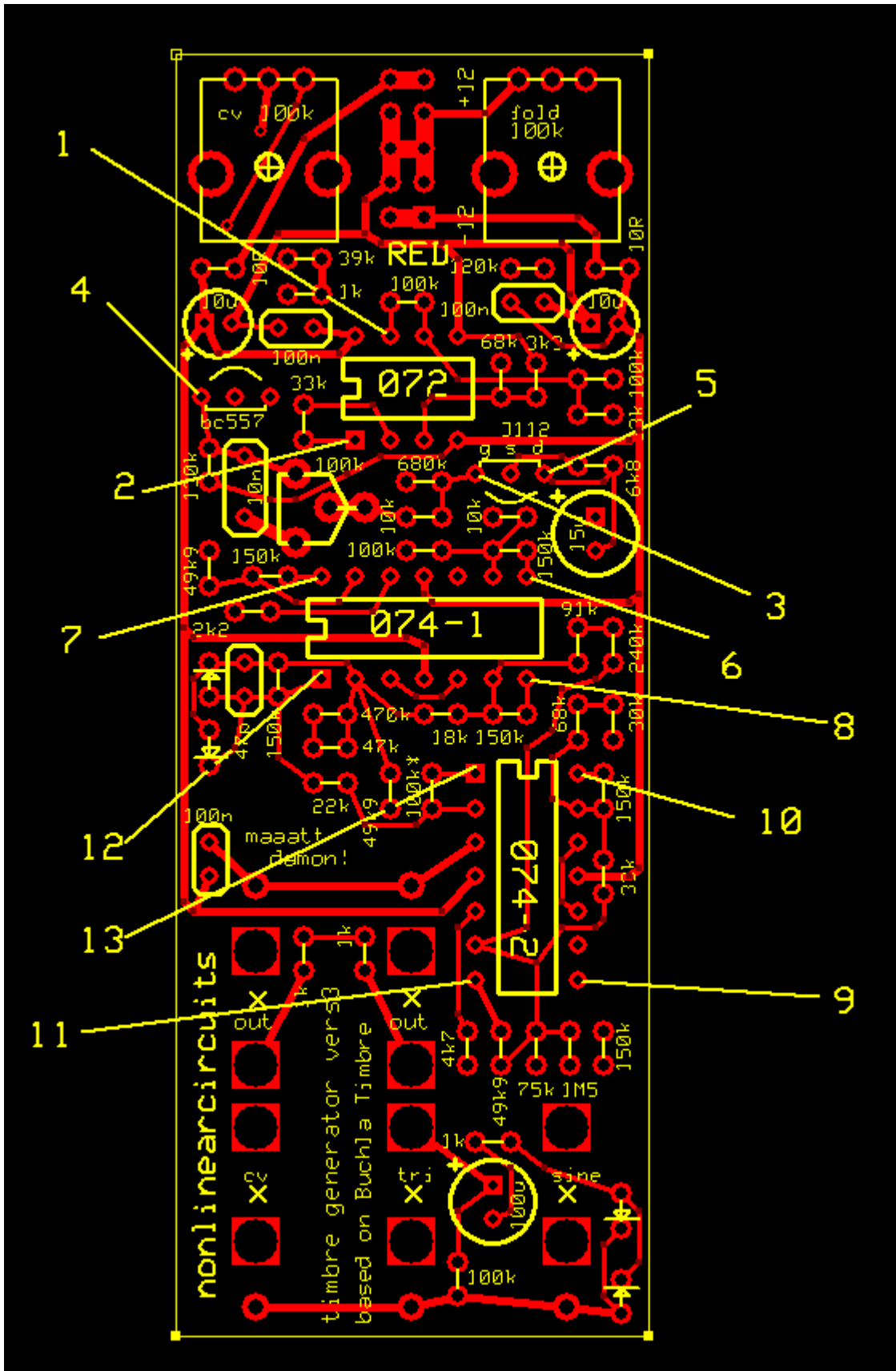

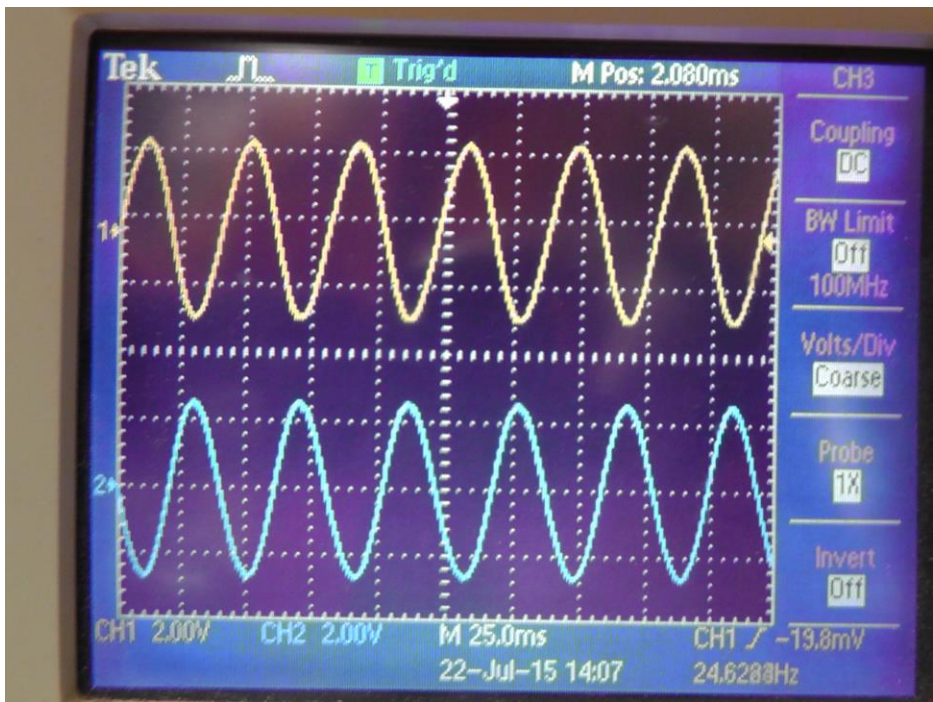

1

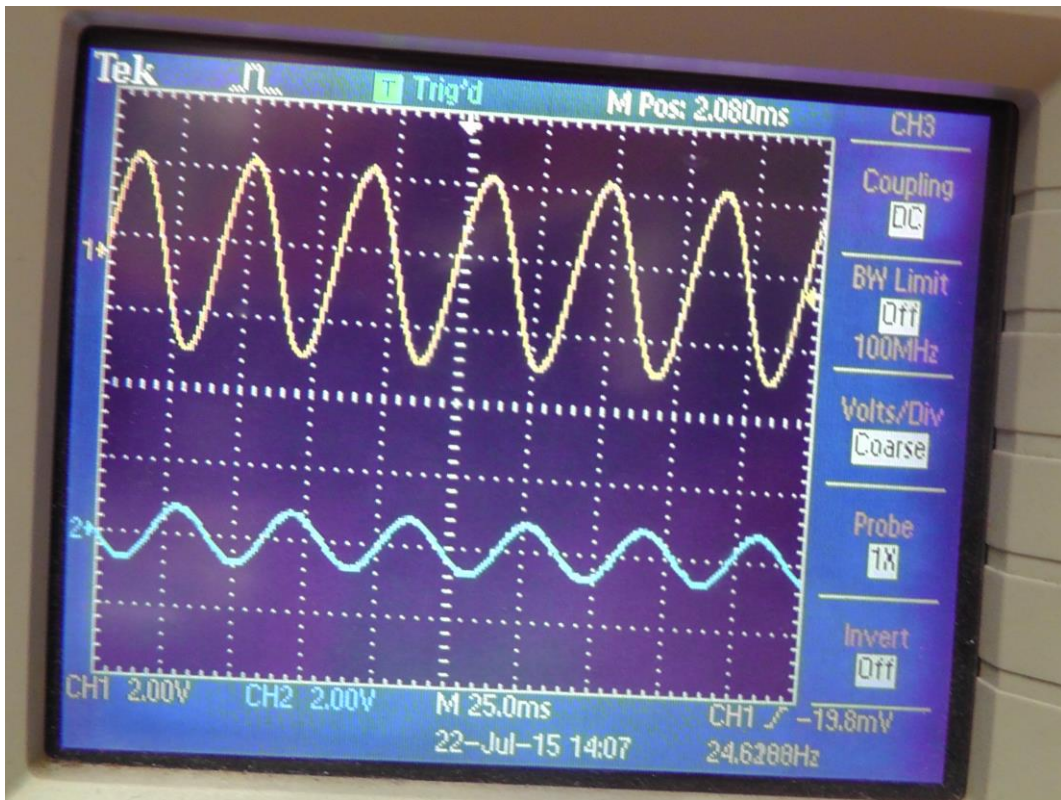

2

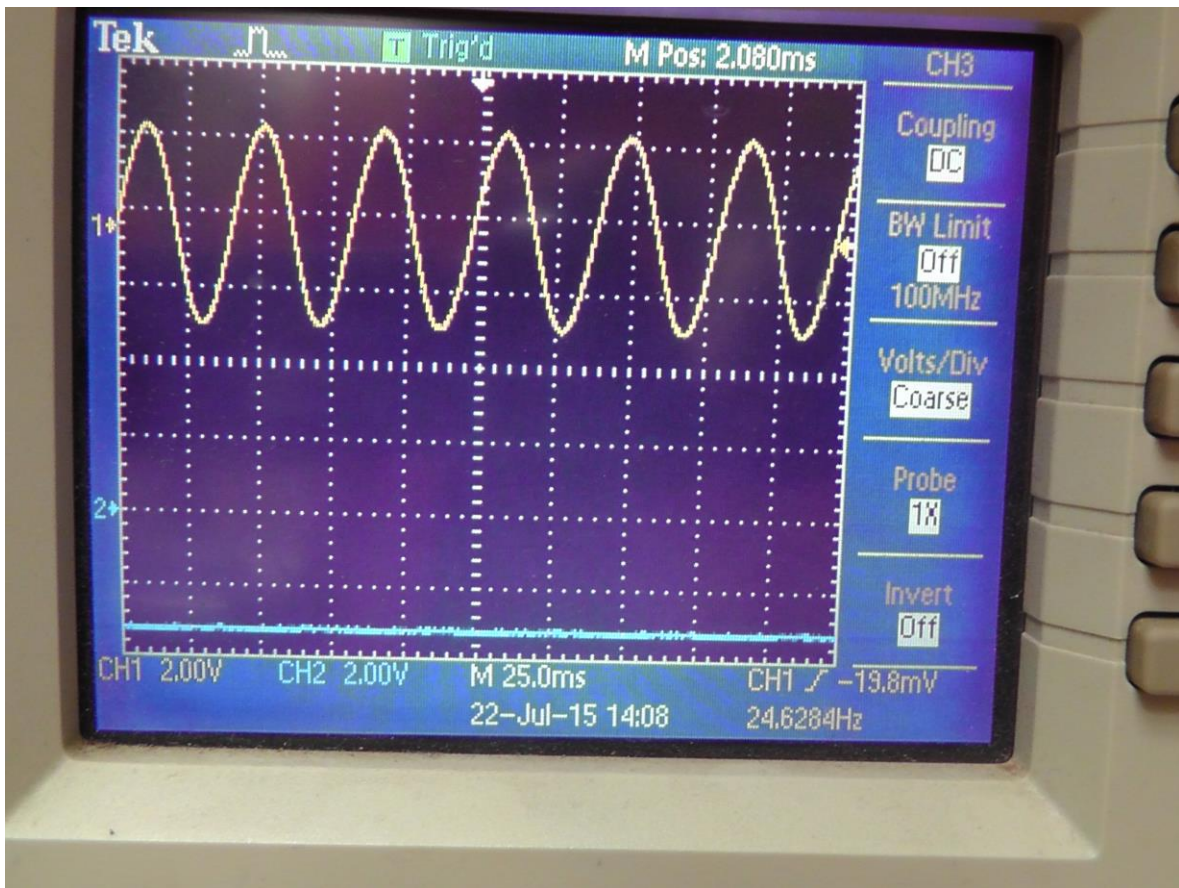

3

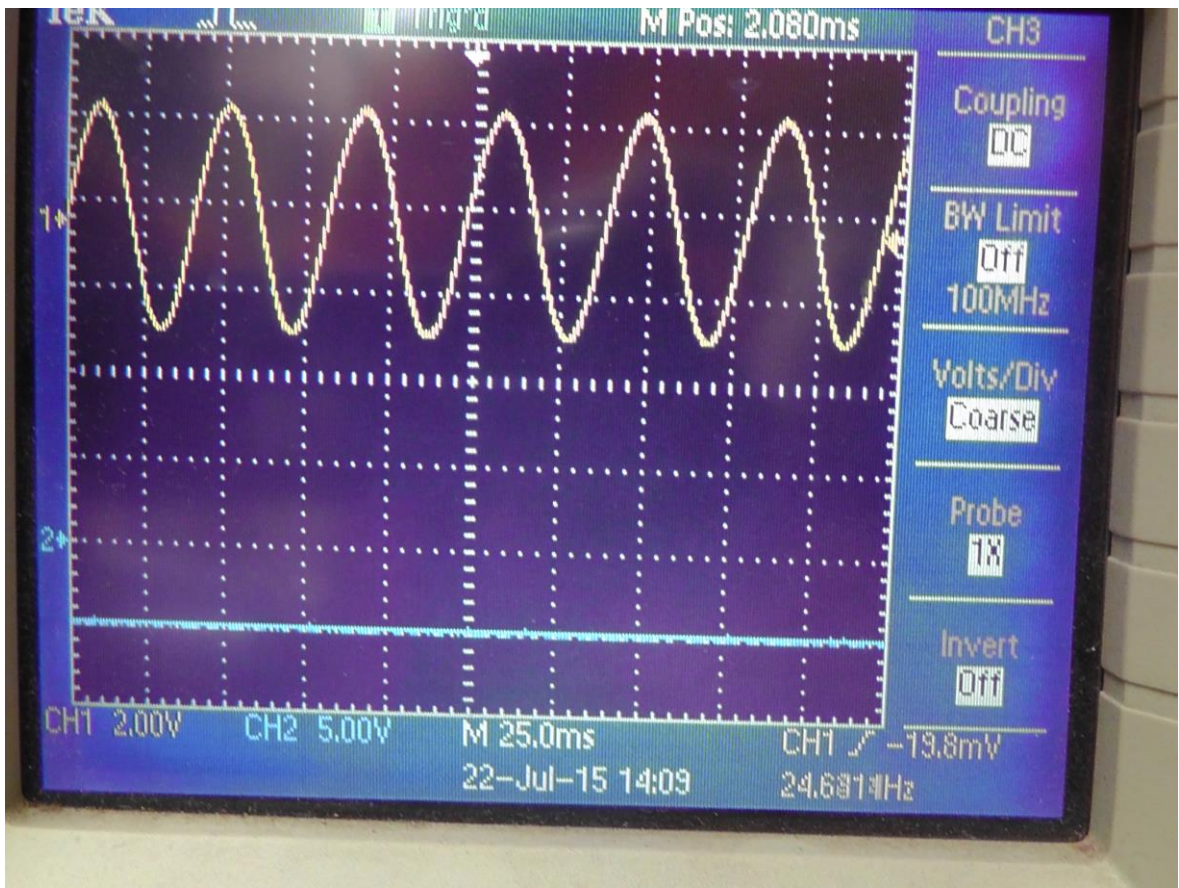

4

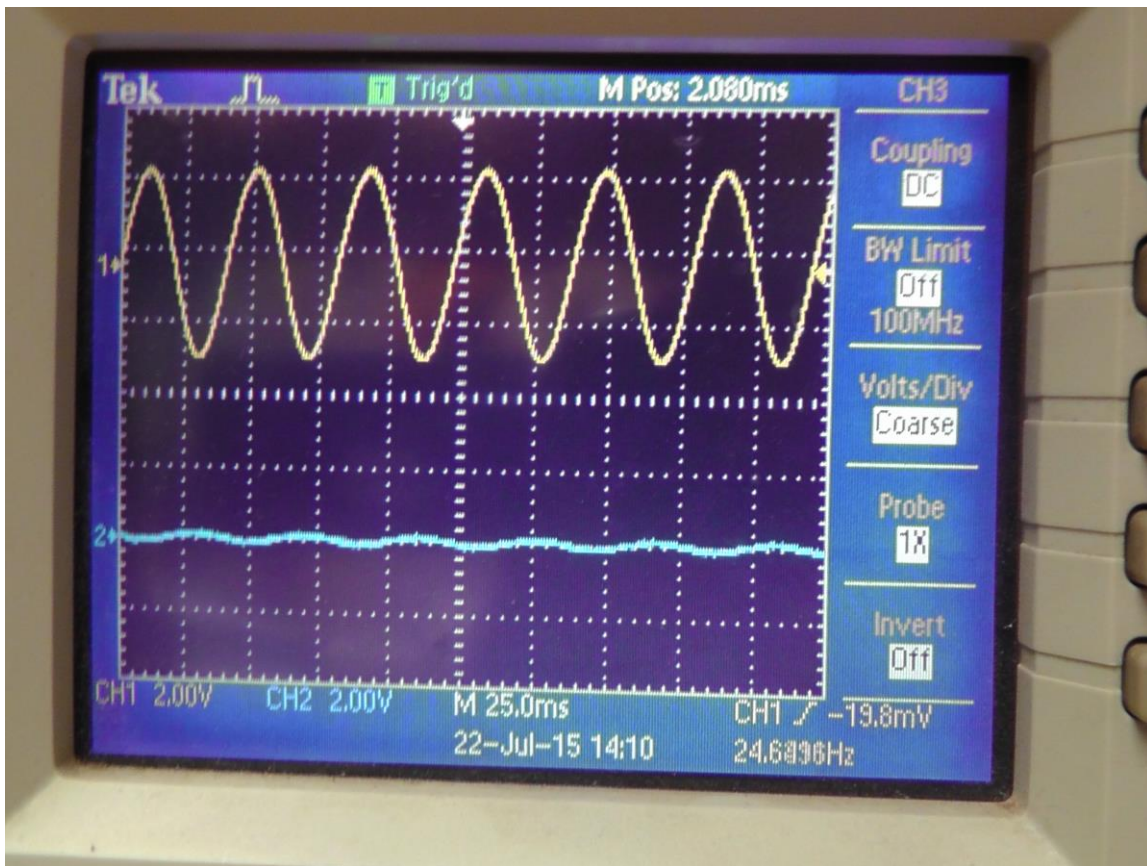

5

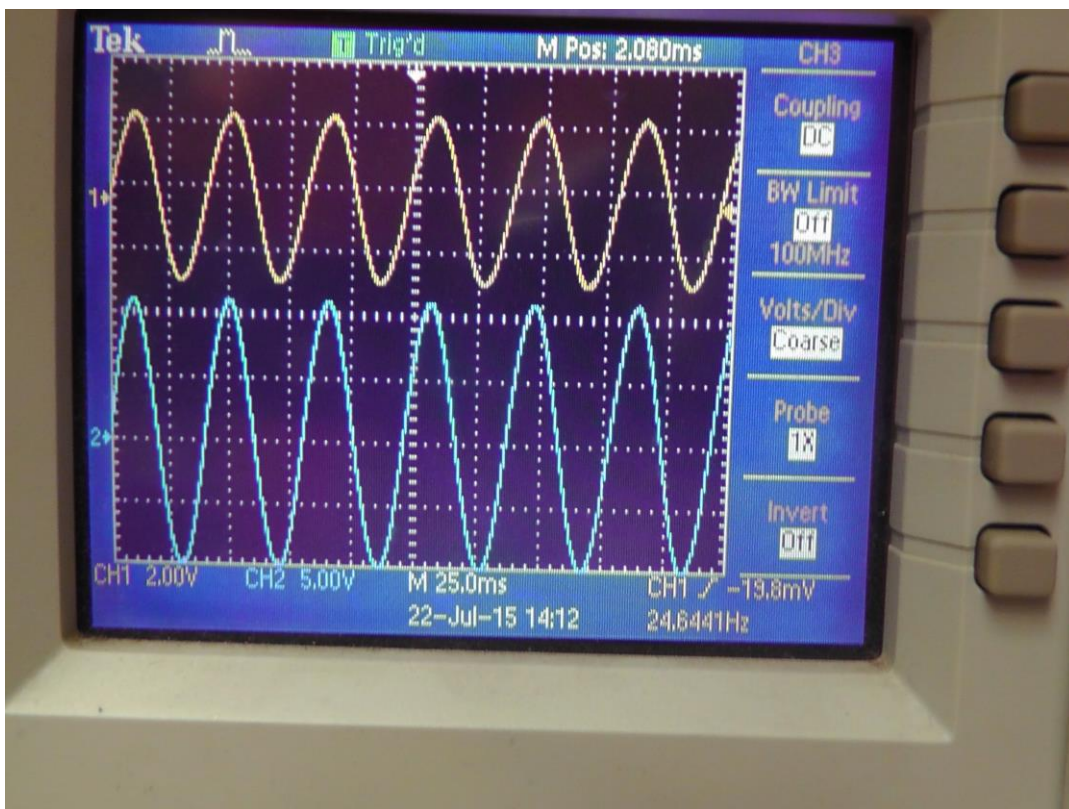

6

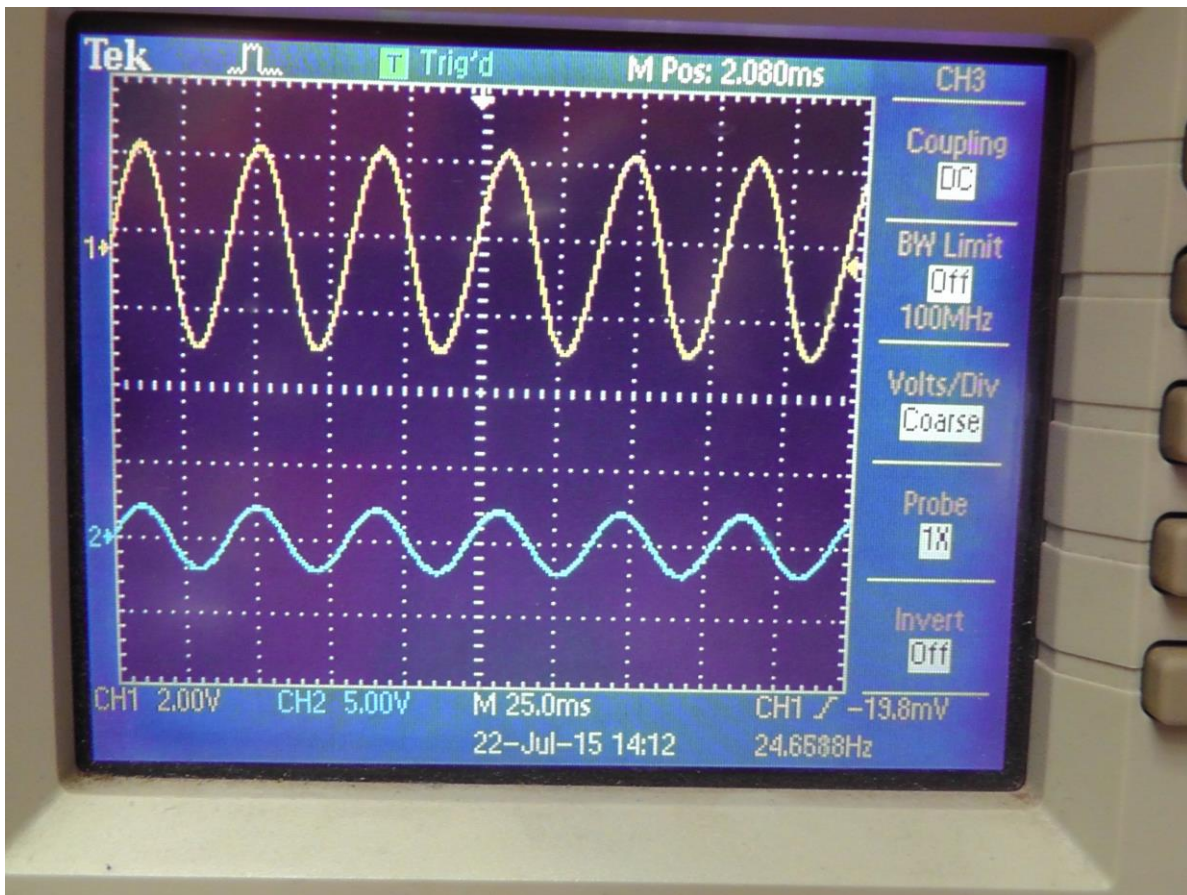

7

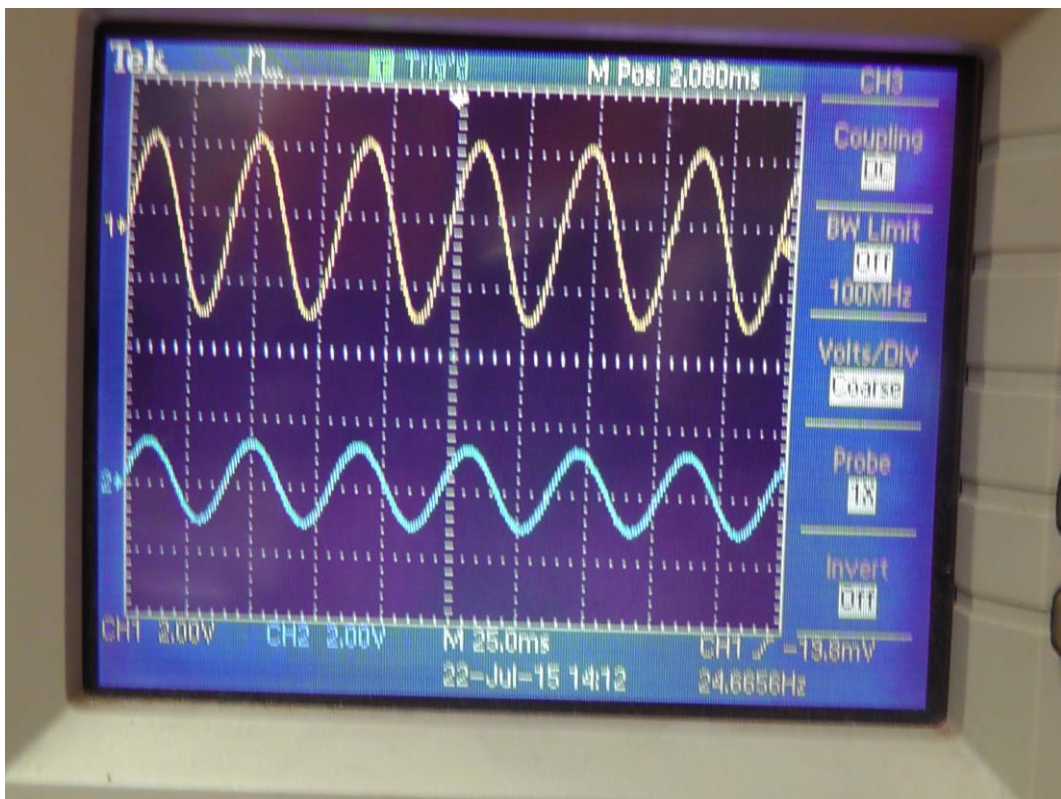

8

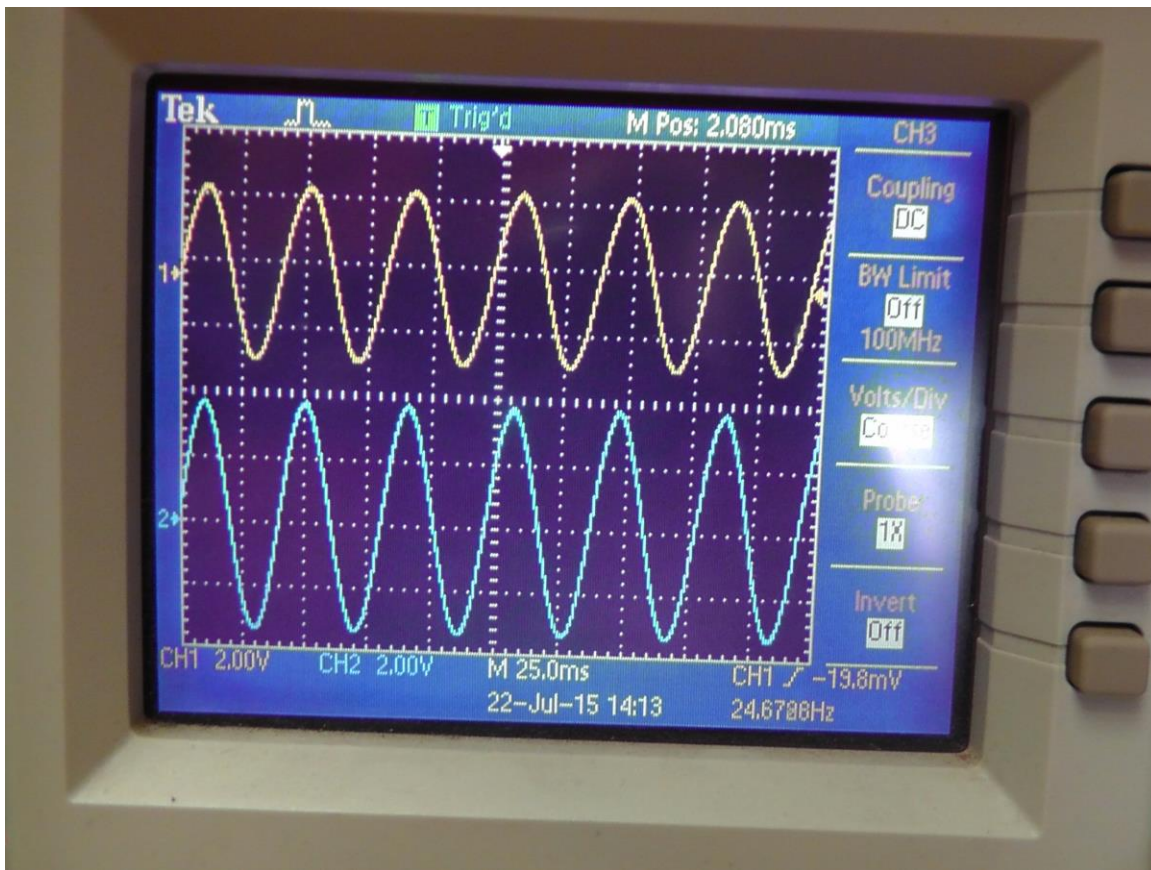

9

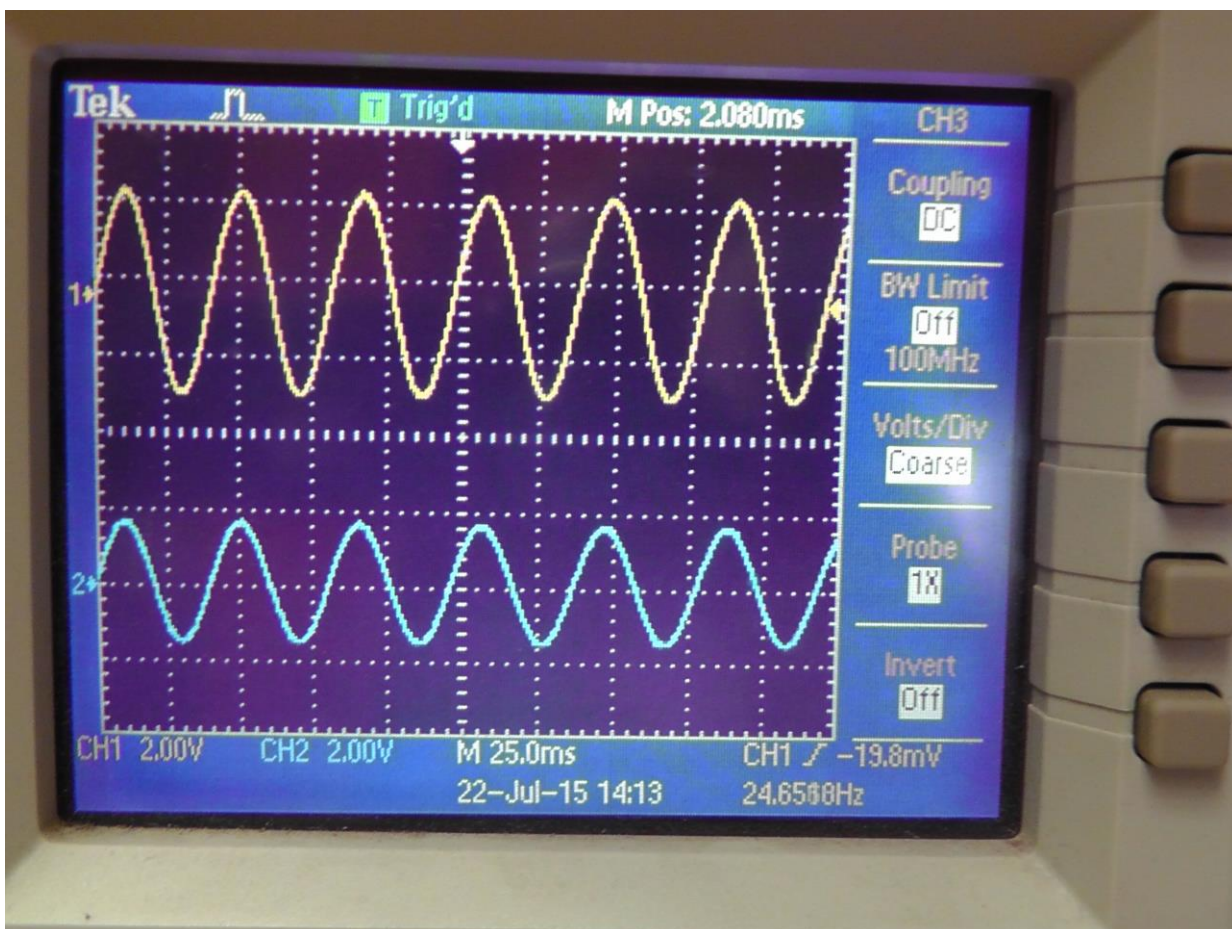

10

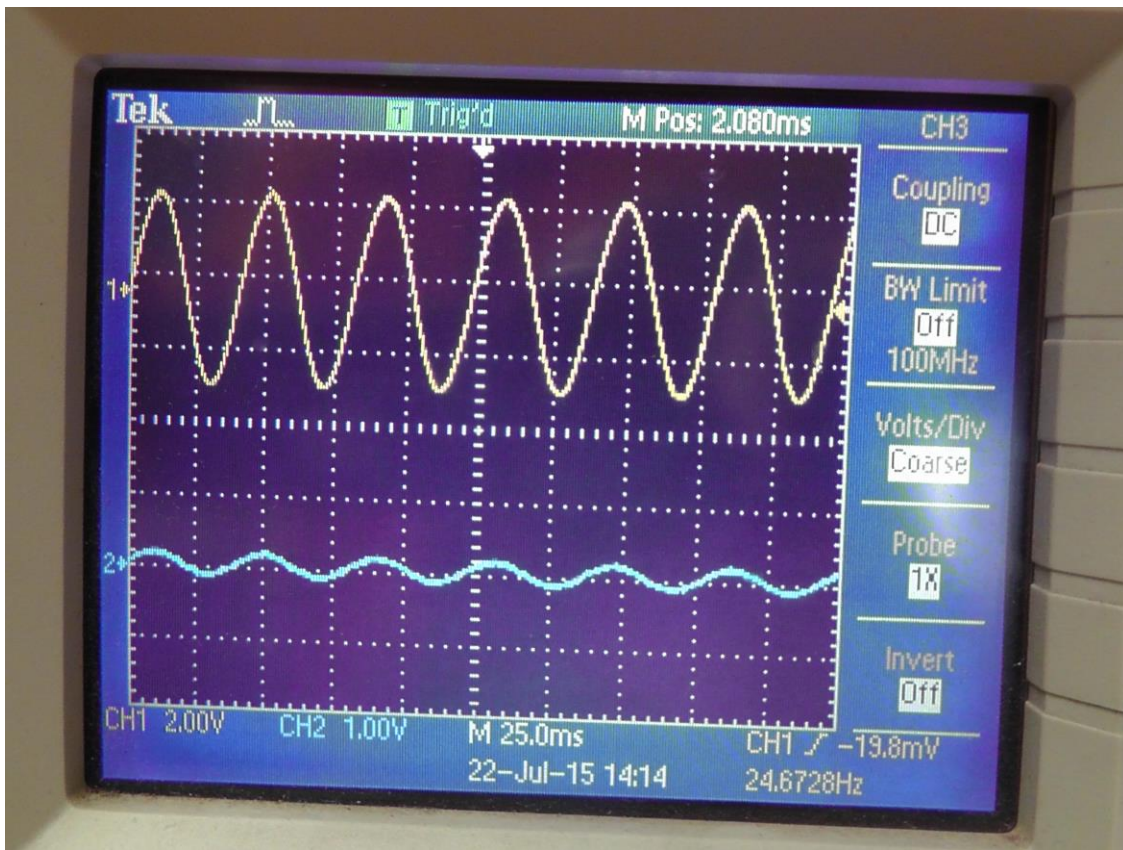

11

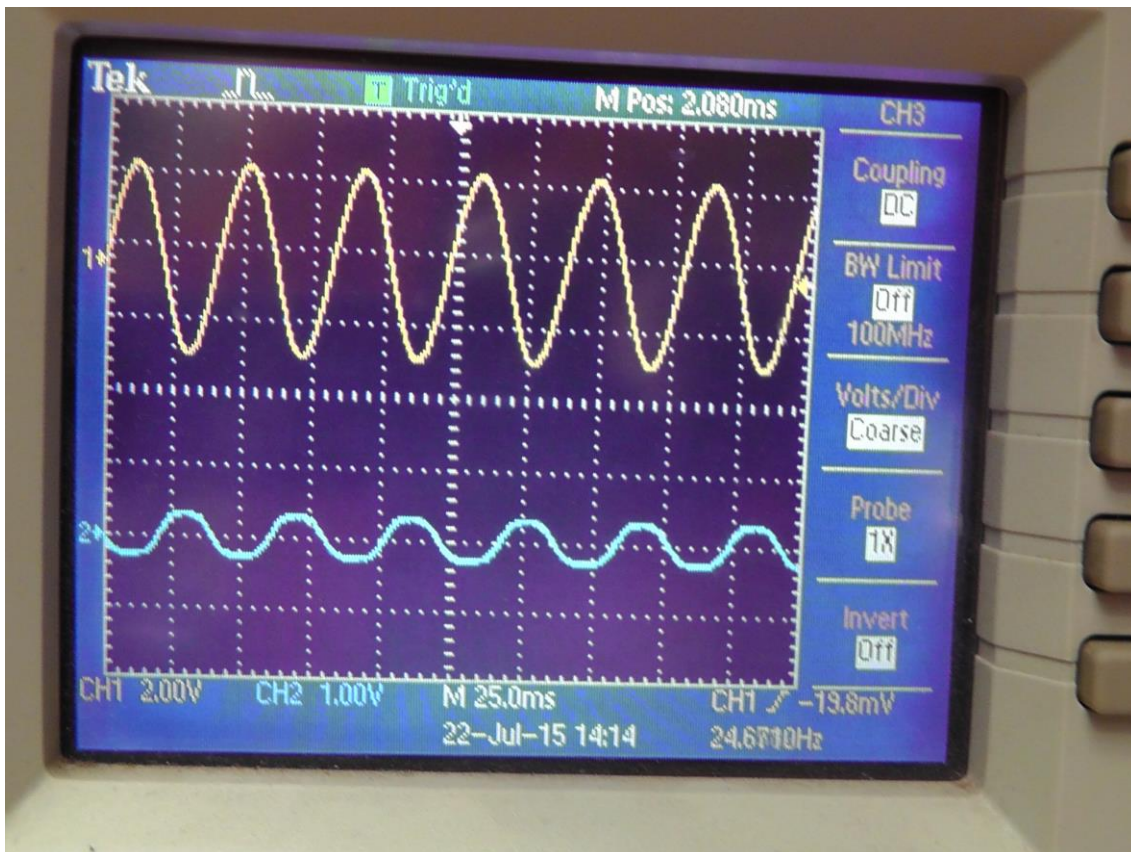

12

